

Report of Project Manager

Michael S. Zisman

CENTER FOR BEAM PHYSICS

Neutrino Factory and Muon Collider Collaboration Project Manager

NFMCC Meeting-IIT

March 15, 2006



Outline



- Introduction
- FY05 accounting
- Recent R&D accomplishments
- FY06 budget
- FY06 plans
- 5-year R&D plan
- Summary and outlook

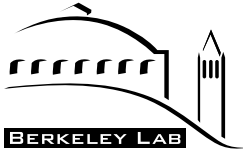

Introduction



- Since FY03, the **NFMCC** budget has been nearly flat-flat
 - we remain hopeful of getting increased support from DOE and NSF

Year	DOE-base (\$M)	DOE- NFMCC (\$M)	TOTAL (\$M)
FY00	3.3	4.7	8.0
FY01	3.0	3.2	6.2
FY02	3.0	2.8	5.8
FY03	2.1	1.4	3.5
FY04	2.2	1.8 ^{a)}	4.0
FY05	1.9	1.7	3.6
FY06	1.8	1.8	3.6

^{a)} Includes \$0.4M supplemental funds

- We are presently committing funds to **MICE** and **MERIT**
 - and supporting the International Scoping Study (**ISS**)
- By juggling projects across fiscal year boundaries and careful prioritization, we continue to make progress, but
 - only contingency on deliverables is time
 - simulation effort weakened by lack of post-docs

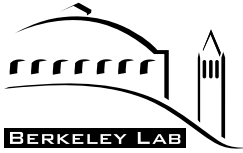

Introduction



- Hardware development continues as major focus of FY06 activity
- Simulation effort aimed at reducing Neutrino Factory cost (“Study IIa”) gave good results
 - **ISS** is follow-on to this activity, and future WDS is where it leads
- Simulations of Muon Collider scenario also progressing well
 - scheme compatible with NF “front end” looks interesting
 - solidifies the R&D connection between the two types of facility
- Here I will cover:
 - FY05 accounting and R&D accomplishments
 - FY06 budget and status of current activities



FY05 Accounting



- FY05 budget finalized by Spokespersons and PM in November
- Both MICE and MERIT have become a significant draw on resources
 - substantial M&S funding is now needed
- We are continuing to pursue opportunities for obtaining a coupling coil
 - bid in Switzerland was unsuccessful
 - two options in the U.S. being pursued for FY06
 - MRI grant from NSF (U.-Miss.)
 - supplemental request to DOE

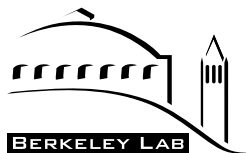

FY05 Accounting



- FY05 **NFMCC** budget (only DOE-**NFMCC** funds)[†]

Institution	COOLING /MICE	TARGETRY	ACCEL./ COLLIDER	RESERVE	TOTAL (\$K)
BNL		578			578
FNAL	187				187
LBNL ^a	365			50	415
ANL	150				150
IIT	115				115
Mississippi	20		15		35
Princeton		40			40
UC-Berkeley	5				5
UCLA	25		50		75
ORNL		85			85
Jlab	5		10		15
TOTAL (\$K)	872	703	75	50	1700

[†]Also: salary support from BNL, FNAL, LBNL; support from NSF of \$1M (uncommitted from last year); support of Muons, Inc. via SBIR grants



FY05 Accounting



- Supplemental request submitted to DOE in September 2004 (priority order)
 - priorities decided in discussions between Spokespersons and PM

<u>Item</u>	<u>Request (\$K)</u>
1) Targetry magnet cryogenics system	525
2) Coupling coil design and construction	400
3) Tests of RF surface modification techniques	100
TOTAL	1025

- No funding was obtained from this request



FY05 Accounting



- Main goals for FY05
 - continue fabrication of Targetry test magnet
 - continue development of MUCOOL Test Area (MTA) at FNAL
 - continue high-power tests of 805 MHz cavity (not done)
 - continue 201-MHz SCRF development (NSF supported)
 - complete fabrication of 201-MHz NCRF cavity
 - obtain funding for MICE
 - continue exploring and optimizing 6D cooling performance
- Aspirations this year consistent with modest budget
 - delays in making the MTA operational for RF testing were longer than expected

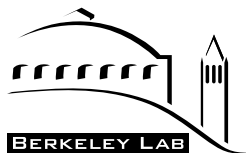

FY05 Accounting



- Before funds were distributed, each institution provided milestones agreed upon by PM
 - milestones (example below) reflect budget allocations for each institution, including base program funds

FNAL [Geer]

Milestone

Complete installation of 805 MHz RF capability in MTA
Optimize design of bunching and phase rotation schemes
Complete installation of 201 MHz RF capability in MTA
Test solid 4x4 grid structure at 805 MHz
Test curved Be windows in 805 MHz pillbox cavity
Begin "button tests" with 805 MHz cavity
Begin tests of 201 MHz RF cavity
Install MTA cryogenics infrastructure
Begin installation of MTA beam line

<u>Date</u>	<u>Deliverable</u>
Mar-05	Inspection
Sep-05	MC note prepared
Mar-05	Inspection
Jun-05	MC note prepared
Jun-05	MC note prepared
Jun-05	MC note prepared
May-05	MC note prepared
Sep-05	Engineering note prepared
Aug-05	Engineering note prepared

ANL [Norem]

Milestone

Complete modifications to Northwestern field ion microscope
Evaluate 805 MHz pillbox cavity performance with precurved Be windows
Test breakdown behavior of small samples in 805 MHz cavity
Begin tests of 201 MHz RF cavity
Test RF breakdown model with field ion microscope
Complete initial paper on atom probe tomography

<u>Date</u>	<u>Deliverable</u>
Mar-05	MC report prepared
Aug-05	MC report prepared
Sep-05	MC report prepared
May-05	MC note prepared
Jul-05	MC note prepared
Sep-05	Paper submitted

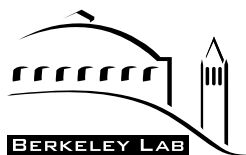

FY05 Accounting



- Summary of FY05 spending is shown below (complete information available in separate handout)

Institution	Collaboration		Base Program	Overall	Contact
	Committed (\$K)	Uncommitted (\$K)	Committed (\$K)	Total (\$K)	
ANL	180	0	66	246	J. Norem
BNL	323	370	900	1223	H. Kirk
FNAL [1]	390	302	759	1149	S. Geer
LBNL [2]	79	365	353	432	M. Zisman
Princeton U.	69.7	0	165	234.7	K. McDonald
UC-Berkeley	5	0	0	5	J. Wurtele
UCLA	75	0	38	113	D. Cline
Mississippi	35	0	0	35	D. Summers
IIT [3]	104	11	0	104	D. Kaplan
Jlab	102	0	0	102	R. Rimmer
<i>NSF MICE Support</i>	<i>17</i>	<i>84</i>	<i>0</i>	<i>17</i>	<i>D. Kaplan</i>
TOTALS [4]	1362	1048	2282	3644	
	1379	1131		3660	

NOTES:

- [1] Uncommitted funds primarily for MTA cryogenics
- [2] Includes \$121K in uncommitted Project Reserve funds maintained by LBNL
- [3] Only DOE funds. NSF funding reported separately.
- [4] DOE totals in Roman type; *additional NSF funding shown in italics*.



Recent R&D Accomplishments



- R&D progress being made on all fronts:
 - Targetry/**MERIT**
 - Cooling/**MICE**
 - Acceleration
 - Simulations/**ISS**

Recent R&D Accomplishments

- Proposal for **MERIT** experiment at CERN approved April, 2005 ("nTOF11")
 - venue change necessitated by elimination of continued A3 line running at BNL

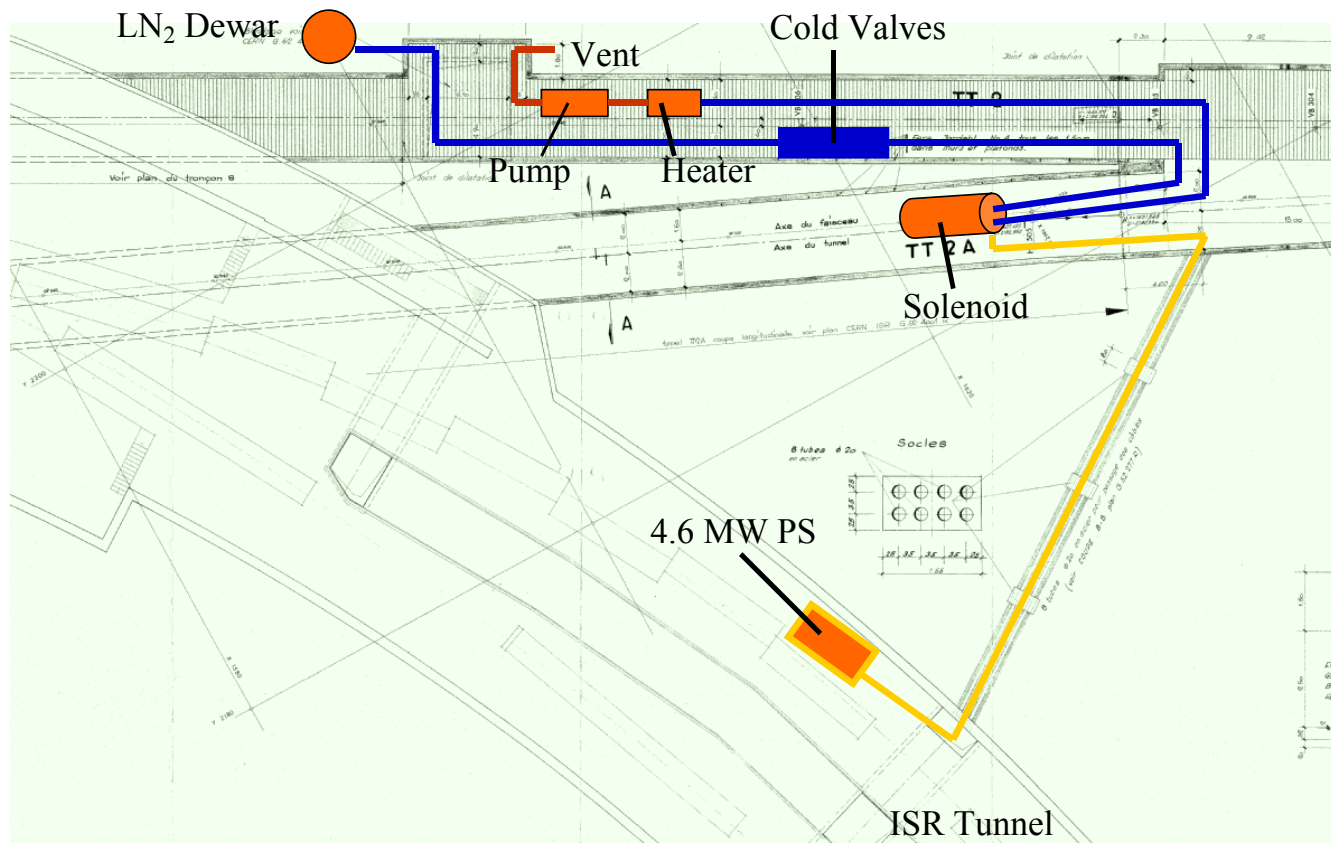

Recent R&D Accomplishments

- Fabrication of 15 T magnet cryostat completed at CVIP
 - magnet presently under test at MIT

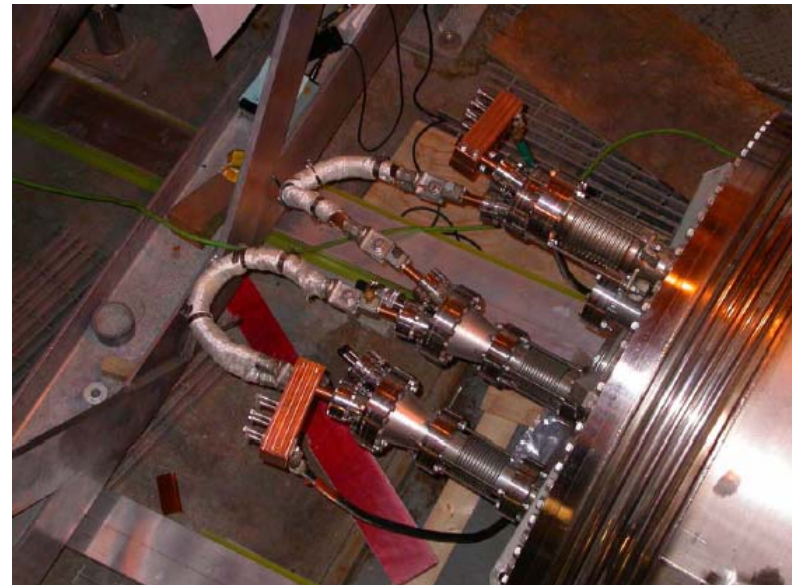
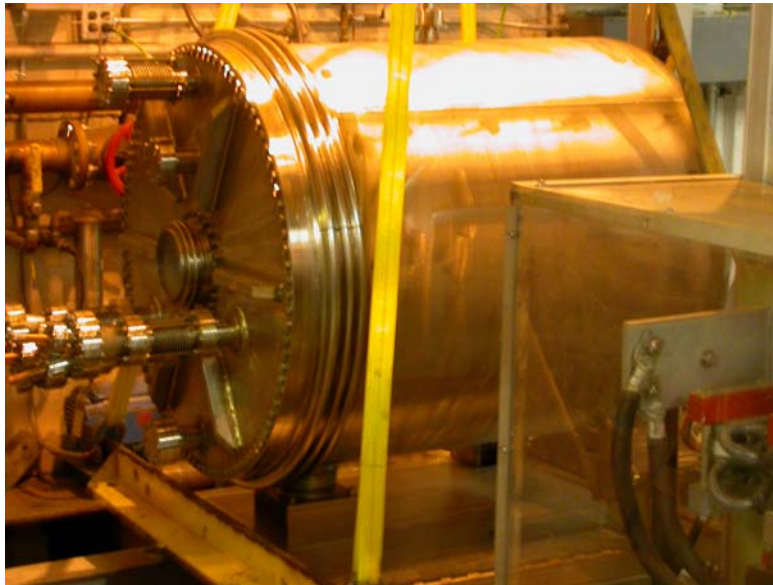

15-T solenoid in test location at MIT

Recent R&D Accomplishments

- Concept for Hg jet system for CERN target test experiment developed in collaboration with ORNL
 - first beam ~April, 2007

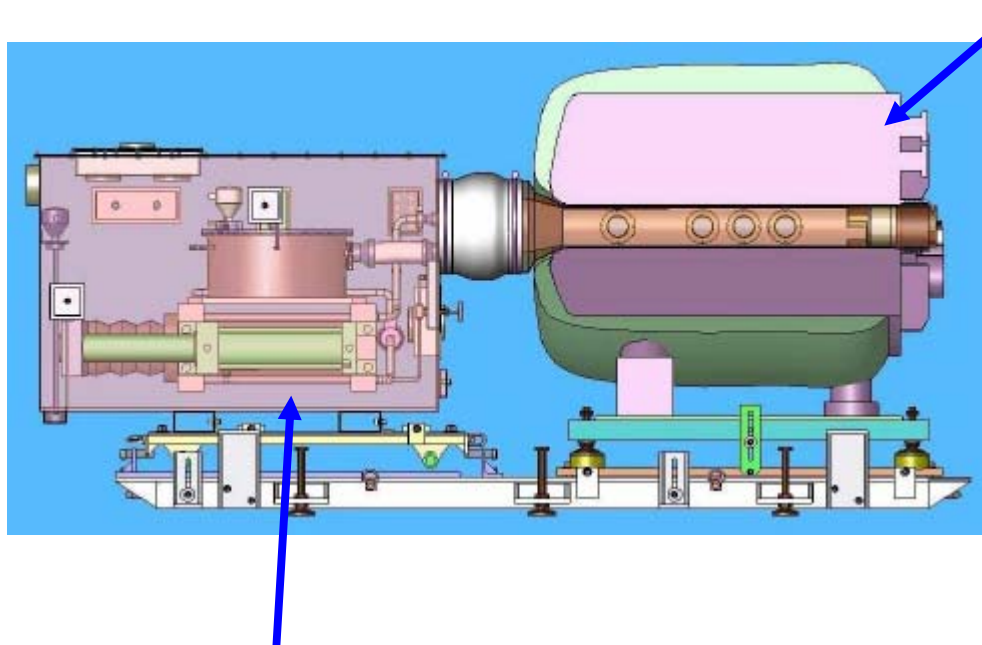

Hg circulation

15-T solenoid

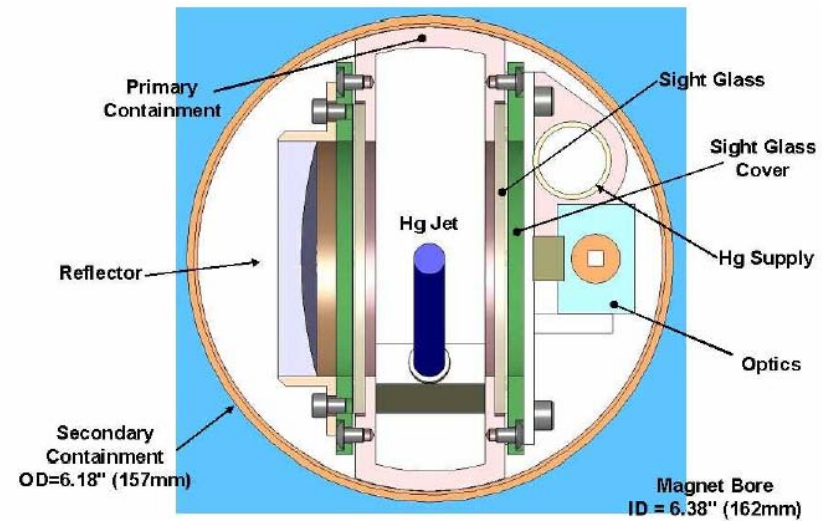

Optical diagnostics



Recent R&D Accomplishments



- Construction of **MUCOOL Test Area** at Fermilab completed
 - absorber, solenoid, and 201 MHz rf cavity integrated here
 - infrastructure for RF tests just completed





Recent R&D Accomplishments



- RF test plan prepared for both 805 MHz and 201 MHz
 - not carried out in FY05 due to lack of RF test facility
- 805 MHz program has now resumed
 - cavity has reached 32 MV/m without magnetic field
- Initial tests of 201 MHz cavity have also recently commenced
 - cavity has reached design gradient of 16 MV/m (no magnetic field)



Recent R&D Accomplishments

- Curved Be windows for 201-MHz cavity fabricated and TiN coated in industry
 - two windows completed, another being fabricated now
 - not installed in cavity yet (using thick Cu windows with TiN)

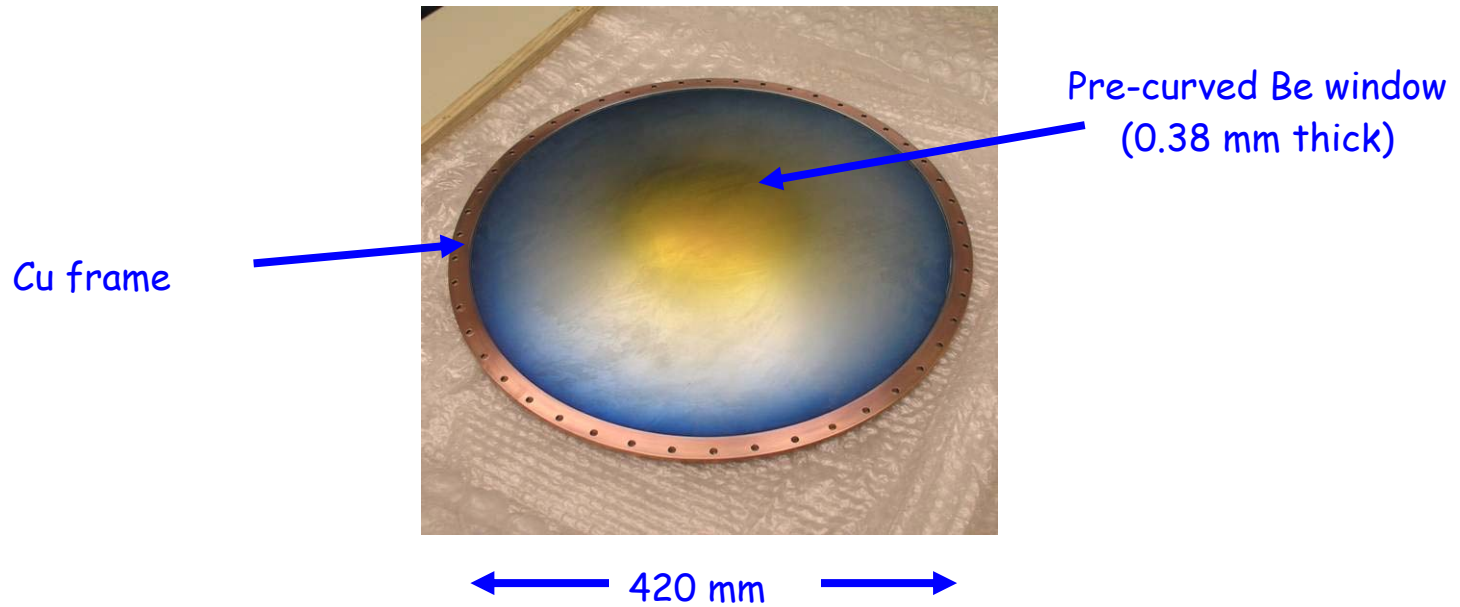

Recent R&D Accomplishments

- 805-MHz program uses pillbox cavity with replaceable windows or “buttons”
 - cavity fits in bore of MTA (née Lab G) solenoid



“Button” for materials tests

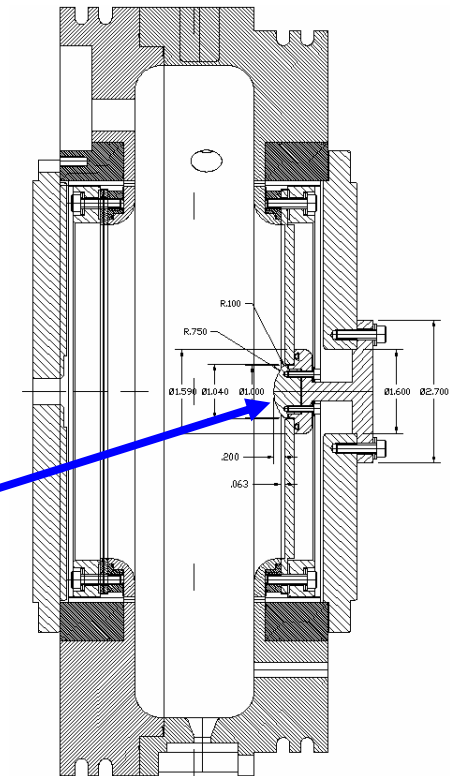

- System set up but not run until recently

- Tested pressurized version of button cavity (**Muons, Inc.**)
 - use high pressure H_2 gas to limit breakdown

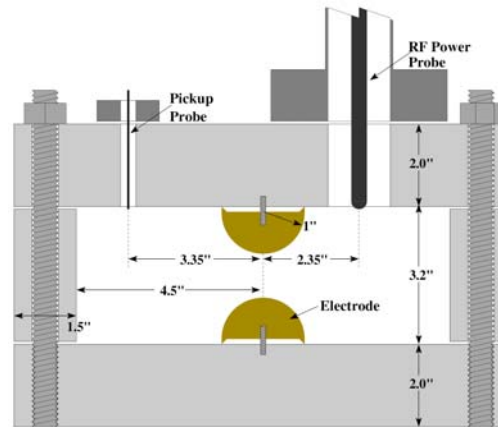

Breakdown Voltage vs. Pressure
(Air - 0.1 inch Gap)

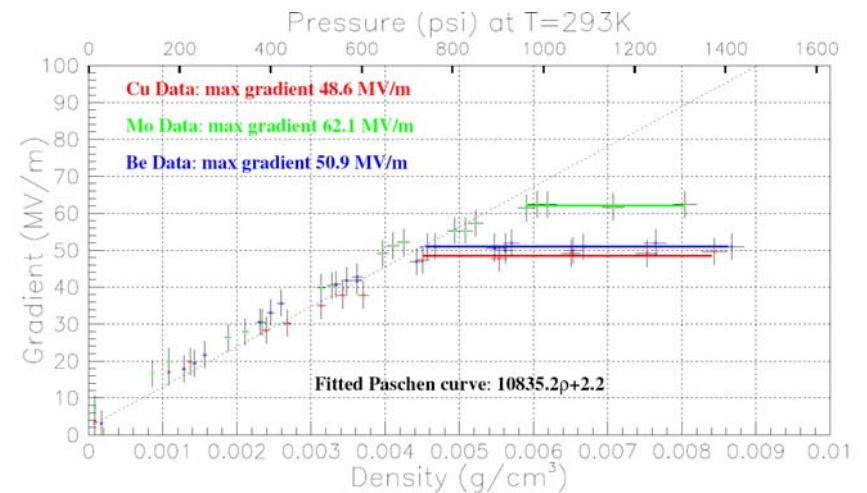
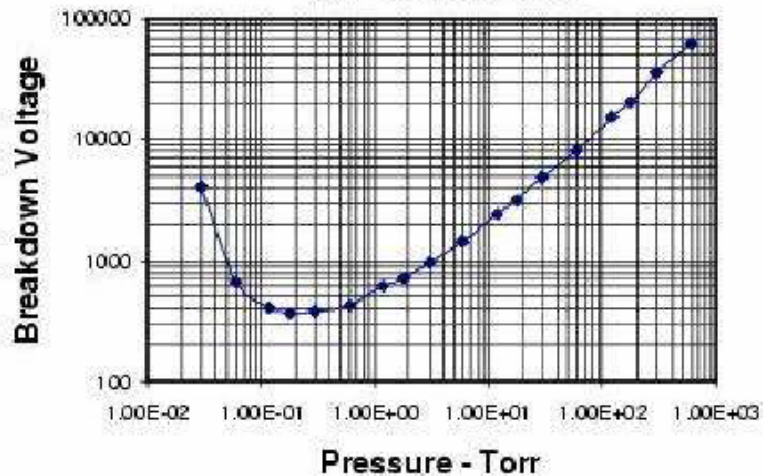

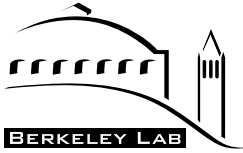

Recent R&D Accomplishments



- Work on 201 MHz scrf cavity for the acceleration system has shifted gears
 - now trying to understand Q slope in terms of Nb coating properties

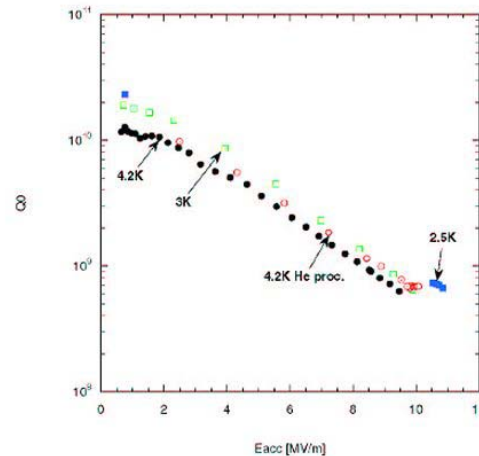

- Several 500-MHz cavities prepared to study Nb sputtering techniques
 - two using hot isostatic bonded Nb-Cu; one using explosion bonded Nb-Cu
 - aiming for first results this summer (NuFact06)



Recent R&D Accomplishments



- Simulations

- main focus in past year was to complete APS Multi-Divisional Neutrino Study (<http://www.aps.org/neutrino/>)
- detailed report written by “Neutrino Factory and Beta Beams Experiments and Development Working Group” (led by **Geer** and **MZ**)
 - <http://www.aps.org/neutrino/loader.cfm?url=/commonspot/security/getfile.cfm&PageID=58766>
- considerable progress made in simplifying front-end systems while maintaining performance
 - developed RF bunching and phase rotation scheme; simplified cooling channel; FFA \bar{G} scheme for final acceleration stages
- **estimated cost of Neutrino Factory reduced 30-40% by this work**

	All (\$M)	No PD (\$M)	No PD & Tgt. (\$M)
FS2	1832	1641	1538
FS2a-scaled (%)	67	63	60



Recent R&D Accomplishments

- Continuing this work in the context of International Scoping Study (**ISS**) of a Future Neutrino Factory Facility
- **ISS** organized by Program Committee, overseen by Wiseperson Group
 - wisepersons provide community oversight and regional balance

Program Committee

Leader	Peter Dornan (ICL)
Accelerator Group	Michael Zisman (LBNL)
Detector Group	Alain Blondel (U. Geneva)
Physics Group	Yorikiyo Nagashima (U. Osaka)

Wisepersons Group

Europe	Vittorio Palladino (INFN-Naples)
Japan	Yoshi Kuno (U. -Osaka)
UK	Ken Peach (Adams Institute)
U.S.	Stephen Geer (Fermilab)

- Present vision is that EU funding for WDS is unlikely before late 2007
 - implies a **need to continue with ISS for another year** in some form



FY06 Budget



- Prepared initial budget for FY06 based on guidance of flat budget
 - Tech Board discussed and approved it
- Budgetary “goal” is to maintain university programs while making some progress on key fabrication activities
- Choices based on the following R&D obligations
 - provide spectrometer solenoids for Phase 1 of MICE
 - provide components for MERIT experiment
- We continue to look for funds to begin fabrication of coupling coil for RF cavity tests at MTA
 - hope for MUTAC support to get additional funding for this purpose

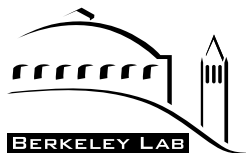

FY06 Budget



• FY06 **NFMCC** budget (only DOE-**NFMCC** funds)[†]

Institution	COOLING /MICE	TARGETRY	ACCEL./ COLLIDER	RESERVE	TOTAL (\$K)
BNL		405			405
FNAL	45				45
LBNL ^a	680			70	750
ANL	150				150
IIT	85				85
Mississippi	20	25	20		65
Princeton		105			105
UCLA	25		45		70
UC-Riverside			20		20
ORNL		95			95
Jlab	5		5		10
TOTAL (\$K)	1010	630	90	70	1800

^aIncludes MICE funding of \$620K.

[†]Also: salary support from BNL, FNAL, LBNL; support from NSF of \$0.1M + \$0.75M MRI grant; support of Muons, Inc. via SBIR grants



FY06 Budget



- Supplemental request submitted to DOE in January 2006 (priority order)
 - priorities decided in discussions between Spokespersons and PM

<u>Item</u>	<u>Request (\$K)</u>
1) Coupling coil design and construction	975
2) MICE design, commissioning, operation, analysis	350
3) ISS travel support	50
TOTAL	1375

- no word yet on this request
- Also submitted MRI request for coupling coil to NSF

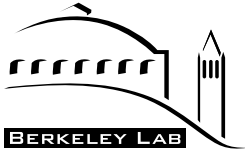

FY06 Plans



- Targetry
 - complete fabrication of MERIT Hg-jet system
- Cooling/MICE
 - test 201 MHz high-gradient cavity (16 MV/m, with magnetic field)
 - test 805 MHz cavity with curved window and “buttons”
 - begin MICE component fabrication; assemble and test MICE tracker
- Acceleration
 - study Q disease and develop mitigation techniques
 - continue beam dynamics studies
- Simulations
 - continue developing cost-optimized front-end for Neutrino Factory
 - explore realistic Muon Collider scenario(s)



5-Year R&D Plan



- Continued low funding and launching of **MICE** and **MERIT** pose challenges for the **NFMCC**
 - prepared 5-year R&D plan last year to indicate funding needs
 - baseline plan assumed “flat-flat” funding
 - incremental plan assumed \$0.4M increase
- Strawman budgets developed for both funding scenarios
 - activities lumped into four broad categories
 - **Cooling**: MUCOOL component R&D
 - **Targetry**: development of high power targets and collection systems, including beam tests at BNL, CERN, or elsewhere
 - **System Studies**: work on acceleration, ring coolers, colliders, performance studies
 - **MICE**: purchase or fabrication of MICE components



5-Year R&D Plan



- Summary of baseline (flat-flat) case is

<u>Activity</u>	<u>FY05</u>	<u>FY06</u>	<u>FY07</u>	<u>FY08</u>	<u>FY09</u>	<u>FY10</u>
Cooling	492	345	345	705	615	225
Targetry	713	640	625	100	100	100
System Studies	195	195	195	295	295	195
MICE	300	620	635	700	790	1280
TOTAL	1700	1800	1800	1800	1800	1800

— comments:

- assumes base program funds remain as in FY06: BNL (\$0.9M); Fermilab (\$0.6M); LBNL (\$0.3M)
- priorities in FY06-07 are MERIT experiment and MICE spectrometer solenoids
- split between Cooling and MICE somewhat flexible

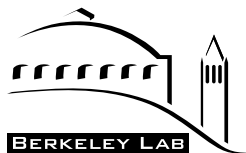

5-Year R&D Plan



- Budget details for **baseline** case

	FY06 (\$K)	FY07 (\$K)	FY08 (\$K)	FY09 (\$K)	FY10 (\$K)	Sum (\$K)
Available	965	980	1405	1405	1505	6260
Cooling	345	345	705	615	225	2235
staff	280	180	180	180	180	1000
absorber	20	20				40
MTA ops.	45	45	45	45	45	225
CC-MUCOOL		100	480	390		970
MICE	620	635	700	790	1280	4025

- **MICE** needs only \$3.4M for Step 5, so extra funds are available
 - for contingency, if needed; for Step 6, if not
- Step 6 requires 1 more year, depending on contingency experience



5-Year R&D Plan



- Plan gives priority to **MICE** spectrometer solenoids during FY06-FY07
 - this was contentious issue in FY06 budget submission
- Advice from MUTAC was that getting coupling coil for MUCOOL RF tests was important (as were **MICE** and **MERIT**)
- In judgment of **NFMCC**, need to launch **MICE** mandated priority choice
 - without this commitment, UK funds for **MICE** Phase 1 (£9.7M) would not have been released
- Plan approved by **MICE** collaboration board (**Blondel letter**)
 - despite their recognition of the importance of the coupling coil
- We continue searching for additional funds to fabricate coupling coil
 - bid in Switzerland failed
 - requested from DOE FY06 supplemental funds and also **MRI** proposal to NSF (via U.-Mississippi)



Summary and Outlook



- Past year productive but more difficult than usual for the **NFMCC**
 - fabrication of **MERIT test magnet** completed
 - **201 MHz NCRF cavity** completed and reached no-field design goal
 - **ISS** launched
 - **MICE** component fabrication launched (spectrometer solenoids and tracker)
 - progress toward self-consistent design of **Muon Collider**
 - Muons, Inc. initial **gas-filled cavity** tests encouraging
- Presented our program to HEPAP AARD Subpanel in February
 - keeping our fingers crossed
- Strong **MUTAC** endorsement of R&D accomplishments and plans are needed to maintain or enhance our budget
 - ***NFMCC will continue to hold up its end of the bargain!***